



## Products Information

Application : Reducer Motor

Description : Oil Seal ,Oil Gauge  
and End Cap

## Application

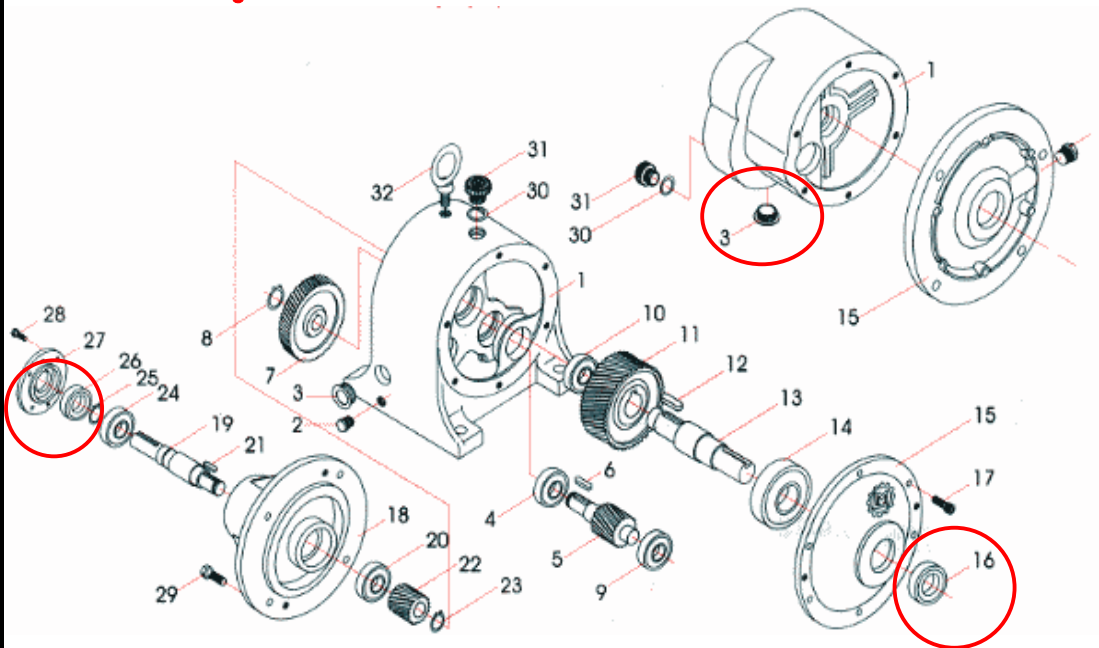
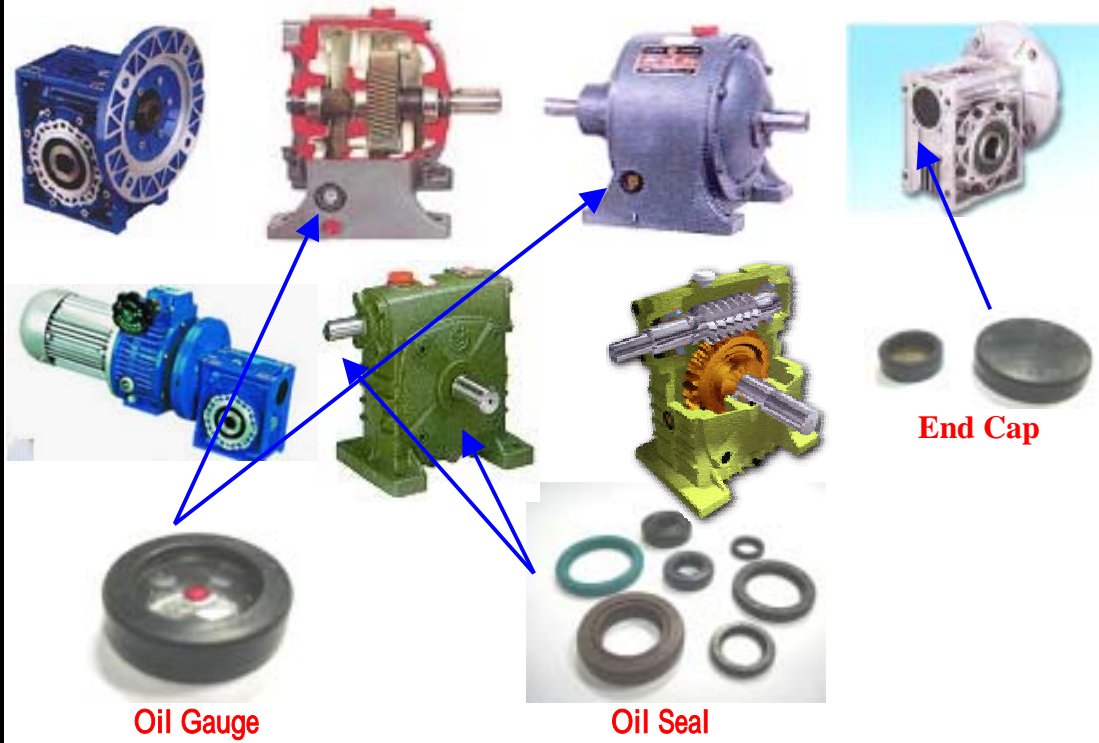



## Products Information

**Application : Application : Reducer Motor**

**Description : Oil Seal ,Oil Glass Gauge  
and End Cap**

1. Type : TC, TC-PL, EC, ECAY Type
2. Material : NBR, HNBR, VITON, NBR+PTFE
3. Application : Reducer Motor
4. Drawing and Shape :

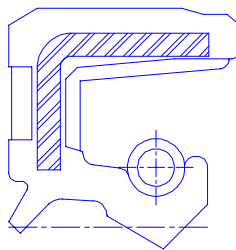

TC

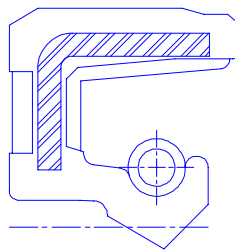

SC

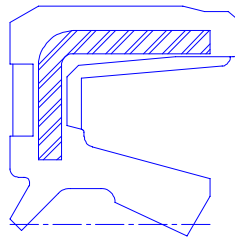

KC

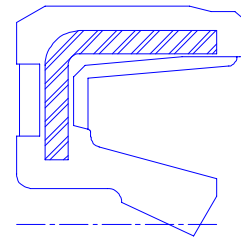

VC

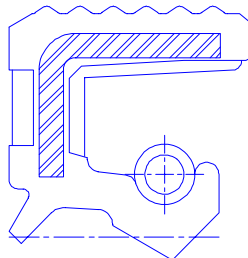

TG

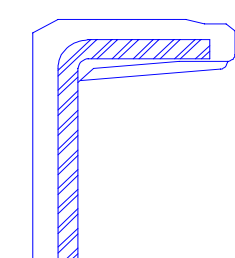

EC

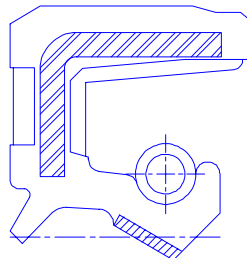

TC-PL

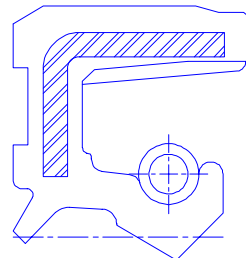

TF